

TOP VIEW

BALL VIEW

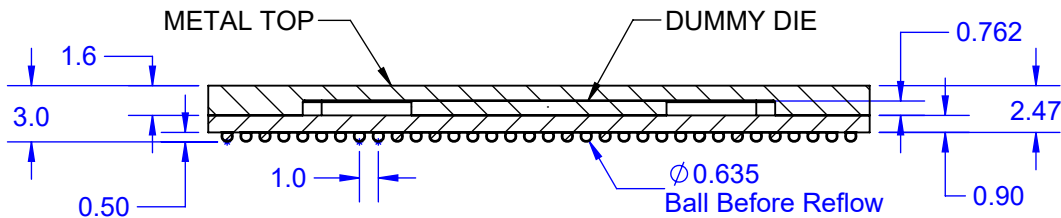
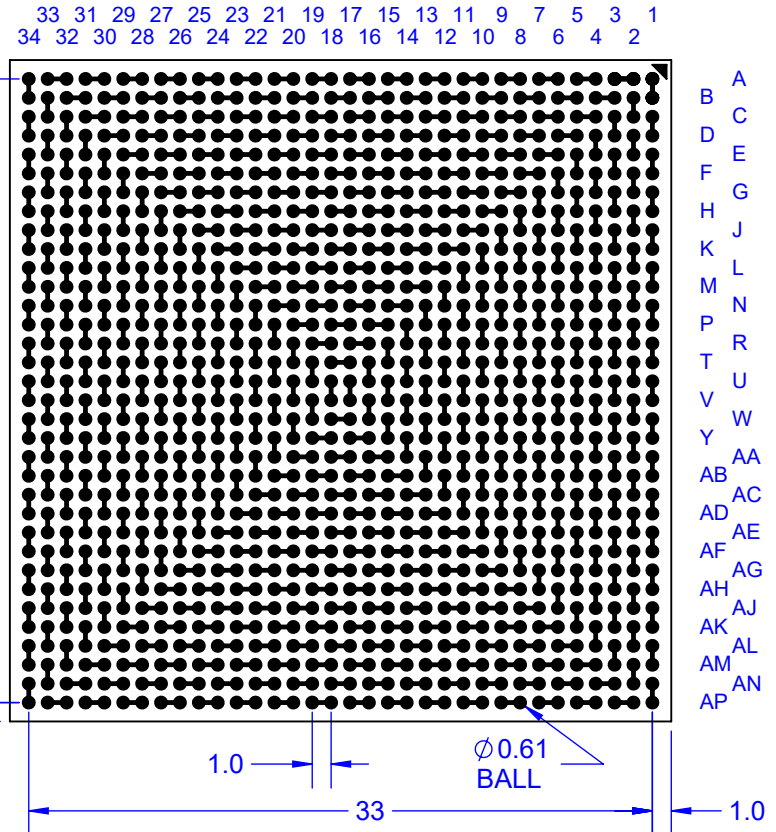
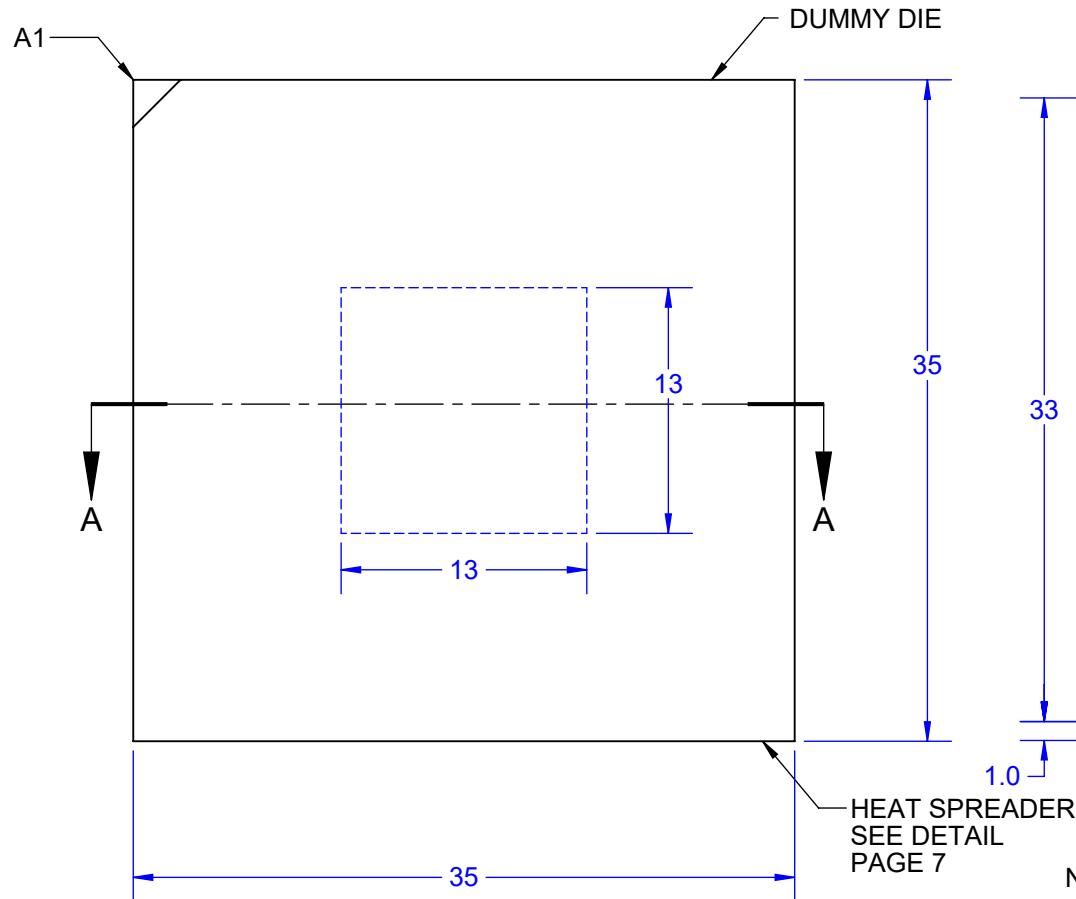

SECTION A-A

Notes: (Unless Otherwise Specified).

- 1) ALL DIMENSIONS: MM.
- 2) SOLDER BALL ALLOY: SEE PART NUMBER TABLE.
- 3) BALL DIAMETER (BEFORE REFLOW) 0.635mm [25 mil].
- 4) SOLDER MASK DEFINED PAD OPENING: 0.508mm [20mil].
- 5) PAD Cu DIAMETER: 0.635mm [25 mil].
- 6) SUBSTRATE MATERIAL: BT.
- 7) DUMMY DIE: Si (SILICON) SIZE OPTIONAL.
- 8) DAISY CHAIN PATTERN (SEE PAGE 2).
- 9) MSL-3 RECOMMENDED BAKING 24 HOURS @ 125°C TO REMOVE MOISTURE PRIOR TO SOLDERING TO PC BOARD.

PART NUMBER TABLE

PART NUMBER	BALL METAL	BALL ALLOY	RoHS	Si DIE
FFG1156T1.0C-DC349D	Sn96.5/Ag3.0/Cu0.5	SAC305	YES	YES
FF1156T.0C-DC349D	Sn63/Pb37	Sn63	NO	YES

APPROVALS	DATE	TopLine®			
DRAWN T. Au	8/18/2021				
ENG M. Hart	8/18/2021	TITLE		FF1156T1.0-DC349D DAISY CHAIN DUMMY	
MFG		SCALE	SIZE	DRAWING NO.	REV
QA		2.5:1	A	513491	A
CUST		DO NOT SCALE DRAWING			SHEET 1 OF 9
REVISED					

BALL VIEW

33 31 29 27 25 23 21 19 17 15 13 11 9 7 5 3 1
34 32 30 28 26 24 22 20 18 16 14 12 10 8 6 4 2

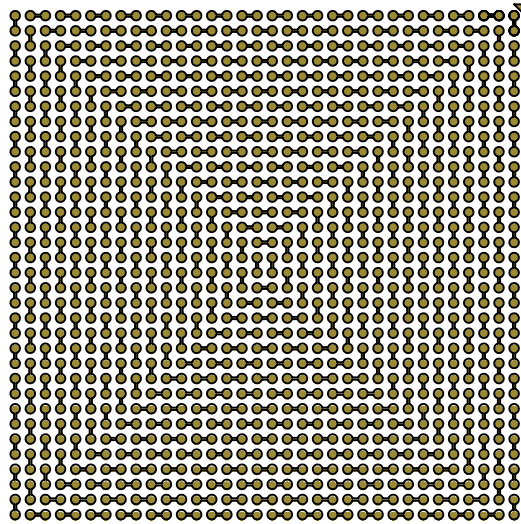

A
B C
D E
F G
H J
K L
M N
P R
T U
V W
Y AA
AB AC
AD AE
AF AG
AH AJ
AK AL
AM AN
AP

BOTTOM SIDE (TOP X-RAY VIEW)

2 4 6 8 10 12 14 16 18 20 22 24 26 28 30 32 34
1 3 5 7 9 11 13 15 17 19 21 23 25 27 29 31 33

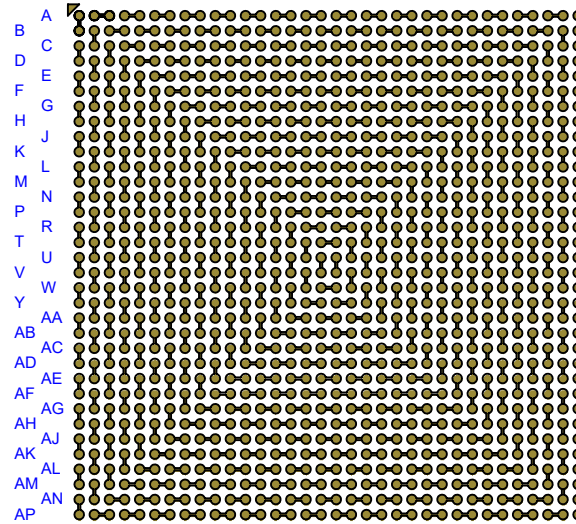

A
B C
D E
F G
H J
K L
M N
P R
T U
V W
Y AA
AB AC
AD AE
AF AG
AH AJ
AK AL
AM AN
AP

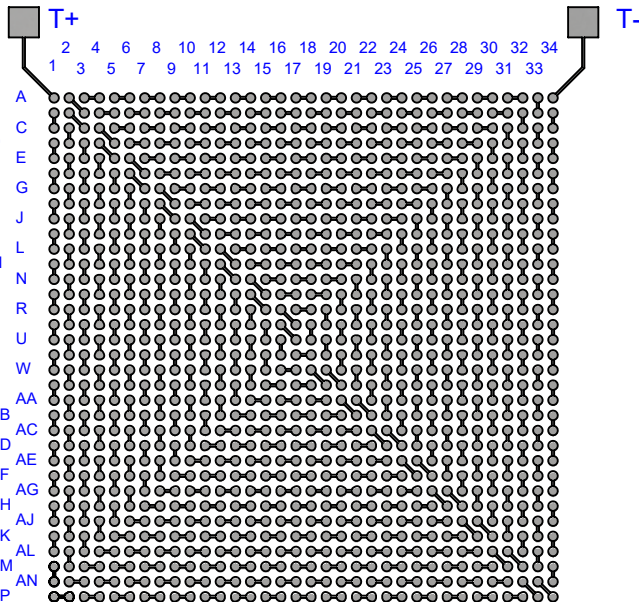

A
B C
D E
F G
H J
K L
M N
P R
T U
V W
Y AA
AB AC
AD AE
AF AG
AH AJ
AK AL
AM AN
AP

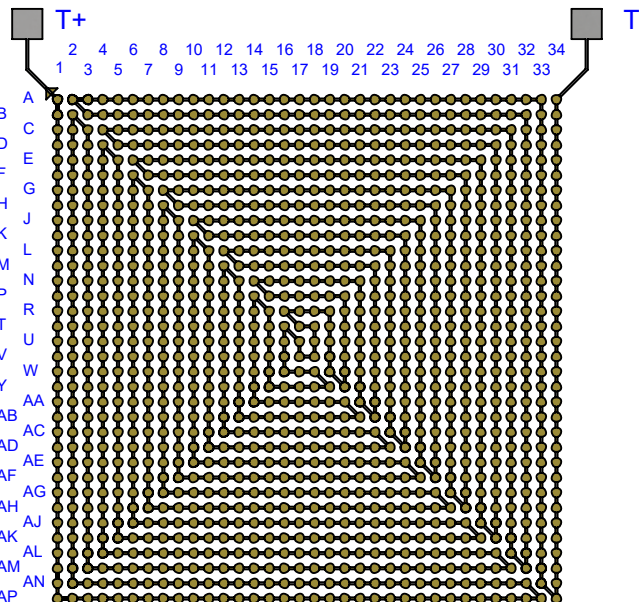

A
B C
D E
F G
H J
K L
M N
P R
T U
V W
Y AA
AB AC
AD AE
AF AG
AH AJ
AK AL
AM AN
AP

TEST VEHICLE BOARD

AFTER MOUNTING

Notes: (Unless Otherwise Specified).

- 1) PCB BOARD DIMENSIONS ARE PRESENTED ONLY AS A GUIDELINE DESIGNERS SHOULD USE THEIR OWN KNOWLEDGE WHEN DESIGNING THE PCB.
- 2) PCB Cu BALL PAD DIAMETER: 0.450 [25 mil].
- 3) PCB DAISY CHAIN TRACING LINE WIDTH: 0.152 [6mil].
- 4) SMD (SOLDERMASK DEFINED) PAD OPENING: 0.508mm [20mil].

TopLine®

TITLE		FF1156T1.0-DC349D DAISY CHAIN DUMMY	
SCALE	SIZE	DRAWING NO.	REV
2:1	A	513491	A
DO NOT SCALE DRAWING		SHEET 2 OF 9	

BALL VIEW

34 33 32 31 30 29 28 27 26 25 24 23 22 21 20 19 18 17 16 15 14 13 12 11 10 9 8 7 6 5 4 3 2 1

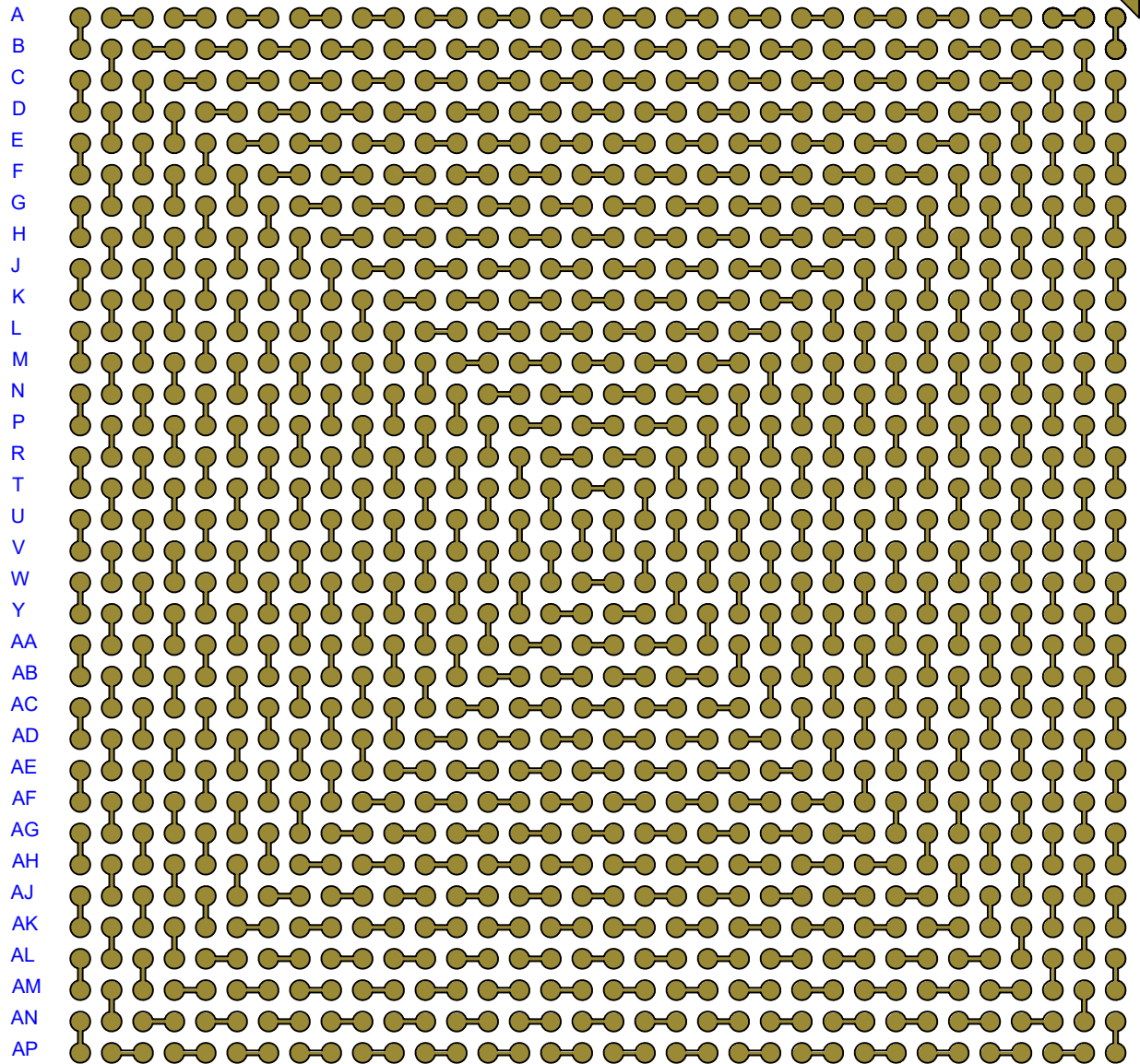

TopLine[®]			
TITLE		FF1156T1.0-DC349D DAISY CHAIN DUMMY	
SCALE	SIZE	DRAWING NO.	REV
4.5:1	A	513491	A
DO NOT SCALE DRAWING			SHEET 3 OF 9

BOTTOM SIDE (TOP X-RAY VIEW)

1 2 3 4 5 6 7 8 9 10 11 12 13 14 15 16 17 18 19 20 21 22 23 24 25 26 27 28 29 30 31 32 33 34

A
B
C
D
E
F
G
H
J
K
L
M
N
P
R
T
U
V
W
Y
AA
AB
AC
AD
AE
AF
AG
AH
AJ
AK
AL
AM
AN
AP

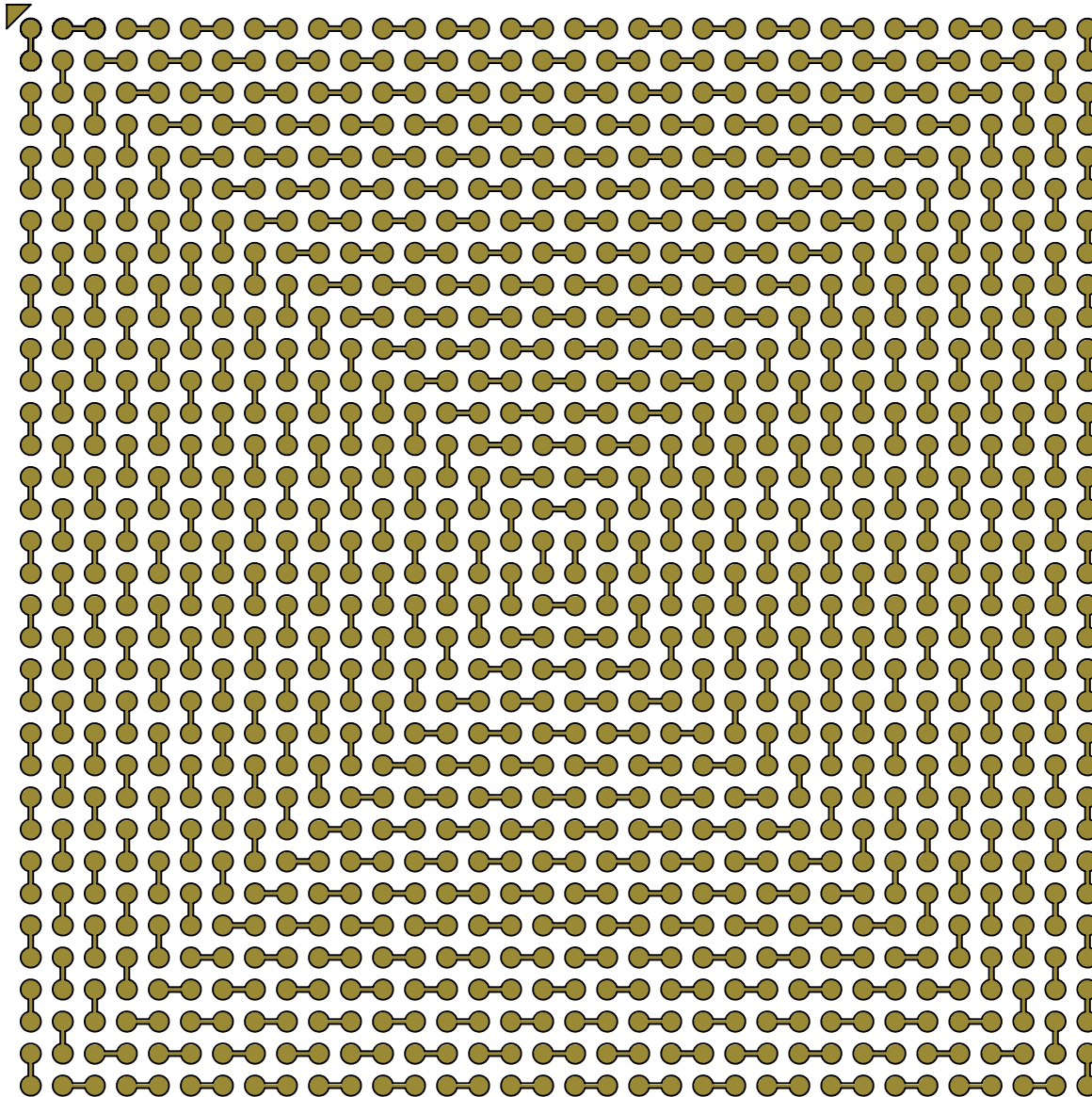

TopLine®			
TITLE		FF1156T1.0-DC349D DAISY CHAIN DUMMY	
SCALE	SIZE	DRAWING NO.	REV
4.5:1	A	513491	A
DO NOT SCALE DRAWING			SHEET 4 OF 9

TEST VEHICLE BOARD

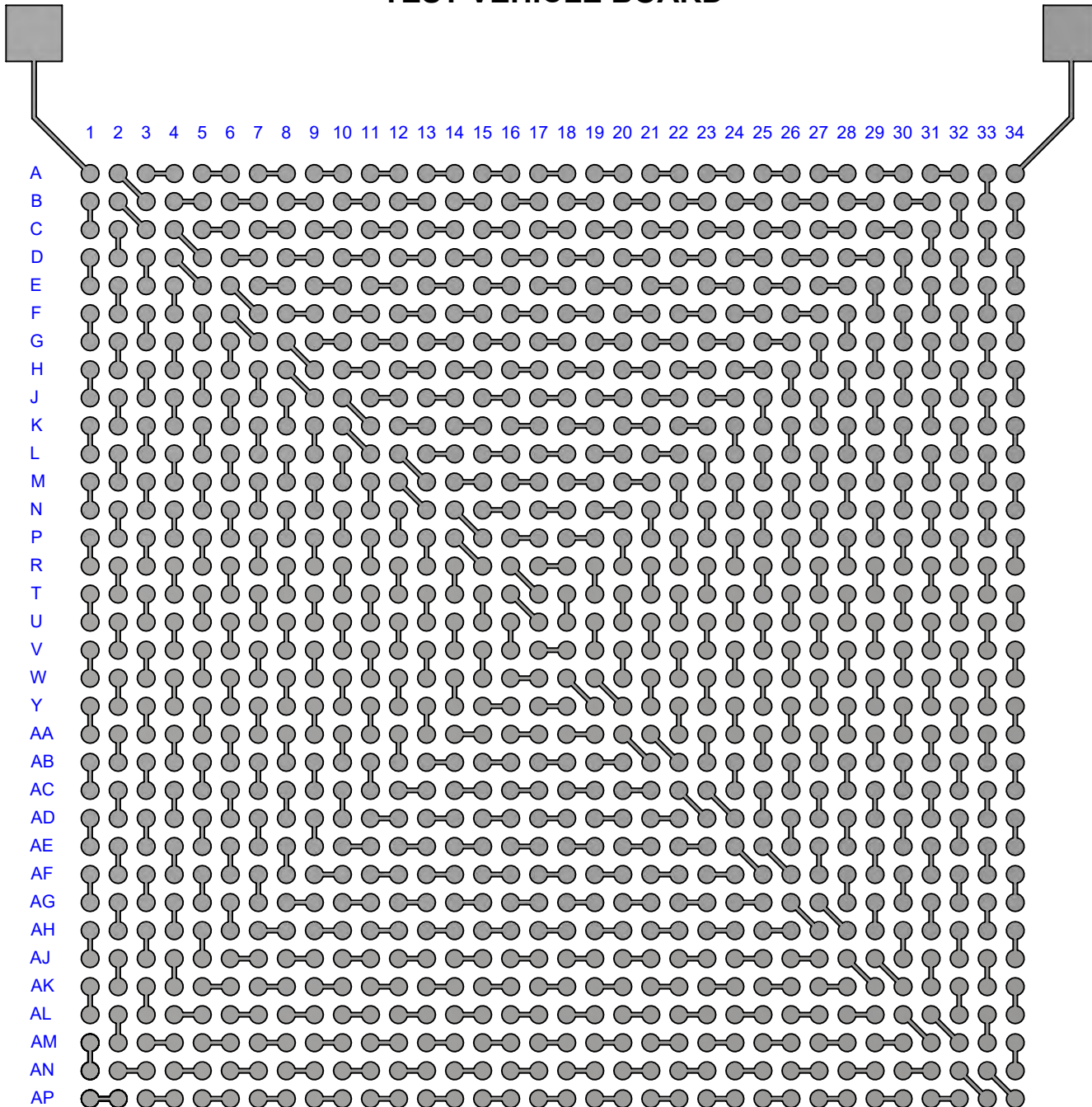

TopLine®			
TITLE		FF1156T1.0-DC349D DAISY CHAIN DUMMY	
SCALE	SIZE	DRAWING NO.	REV
4.5:1	A	513491	A
DO NOT SCALE DRAWING			SHEET 5 OF 9

AFTER MOUNTING TO TEST BOARD

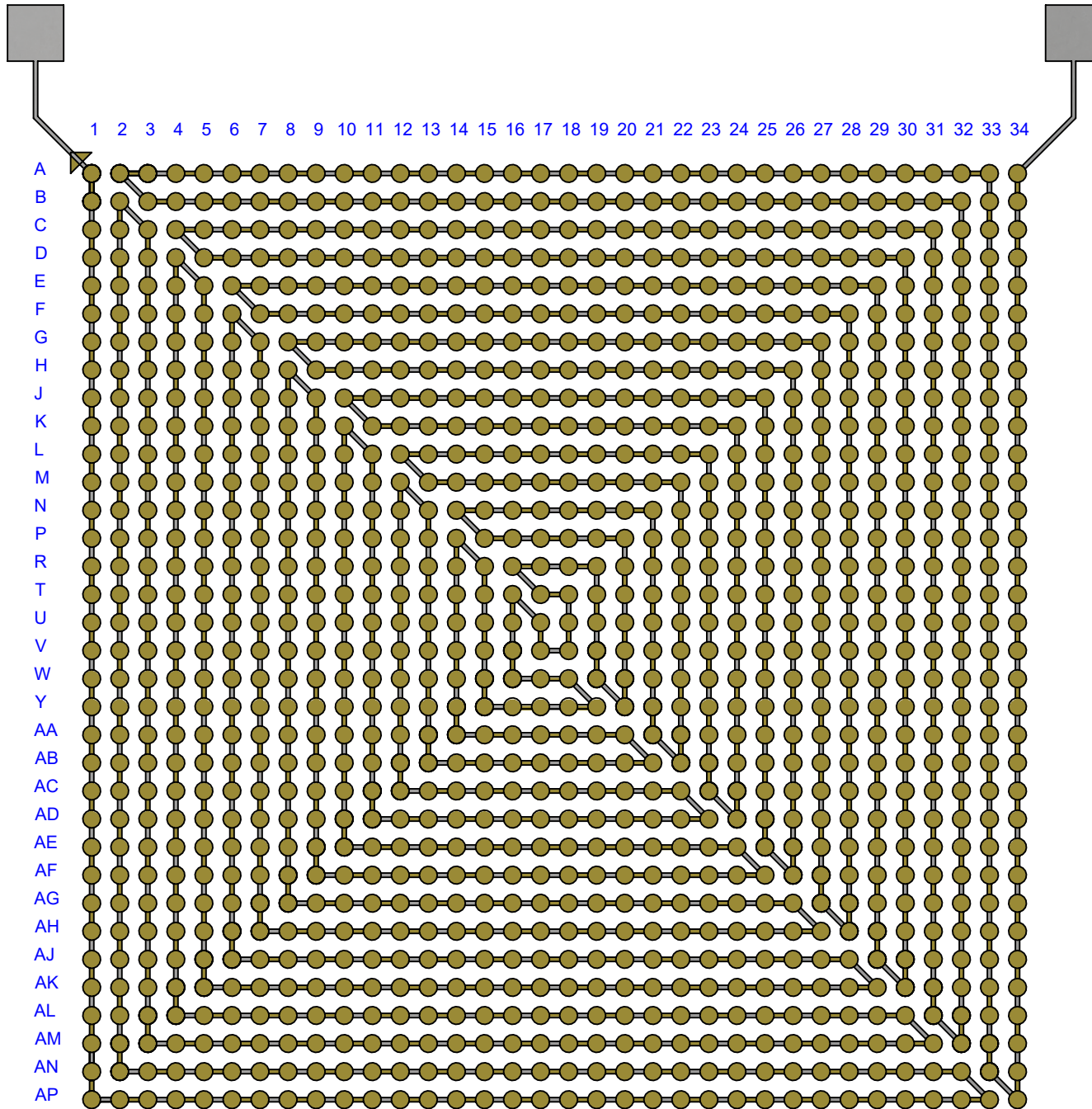

TopLine®			
TITLE		FF1156T1.0-DC349D DAISY CHAIN DUMMY	
SCALE	SIZE	DRAWING NO.	REV
4.5:1	A	513491	A
DO NOT SCALE DRAWING			SHEET 6 OF 9

HEAT SPREADER

CAVITY VIEW

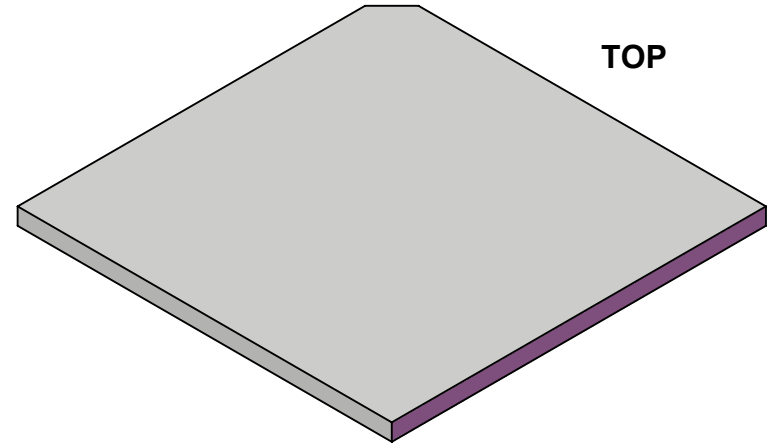
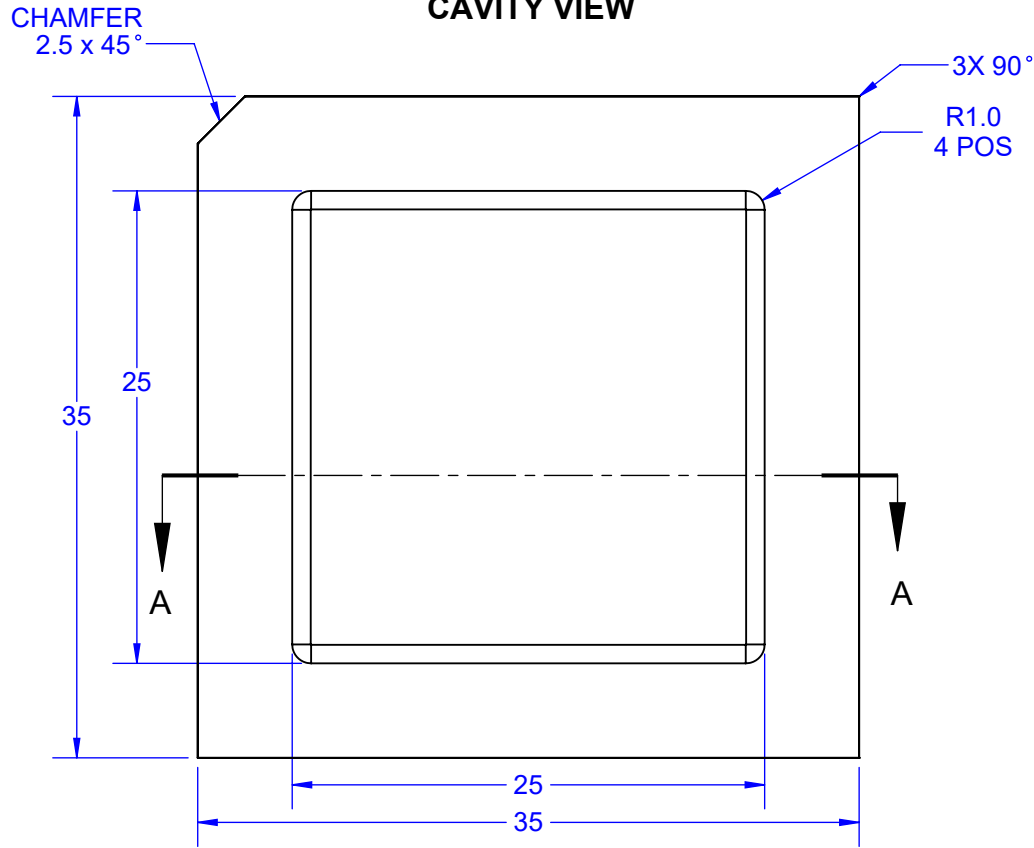

TOP

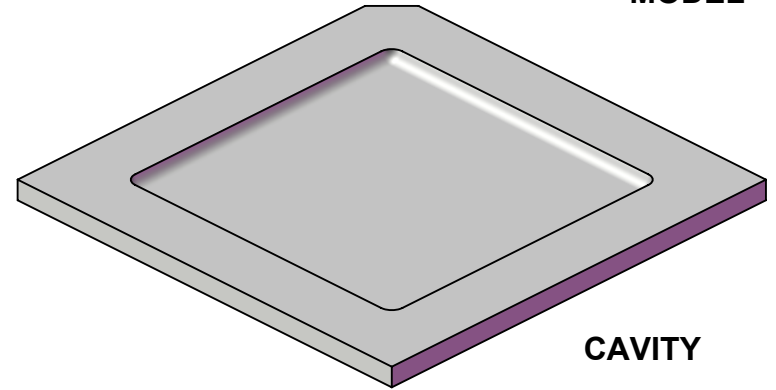

MODEL

CAVITY

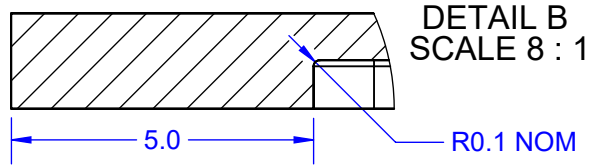

DETAIL B
SCALE 8 : 1

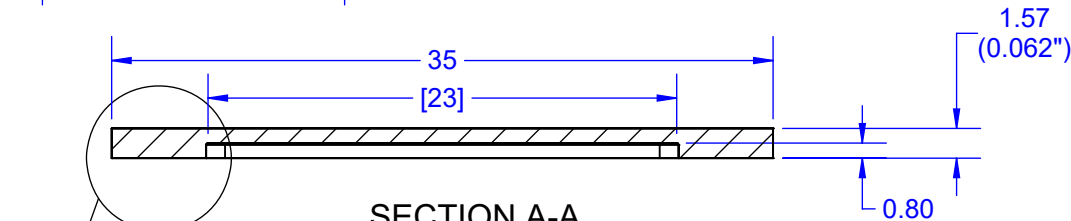

SECTION A-A
SCALE 4:1
SCALE 2.5 : 1

Notes: (Unless Otherwise Specified).

- 1) DIMENSIONS mm
- 2) MATERIAL: COPPER C110 HALF-HARD
- 3) PLATING: ELECTROLESS NICKEL
 - a. PER MIL-C-26074E
 - b. NICKEL (Ni) 0.0002 ~ 0.0004-INCH
 - c. MID-PHOSPHOROUS
 - d. COPPER (Cu) STRIKE

APPROVALS	DATE	TopLine®			
DRAWN T. Au	04/27/2024				
ENG M. Hart	04/27/2024	TITLE F-CAP35A FLAT CAVITY HEAT SPREADER			
MFG		SCALE	SIZE	DRAWING NO.	REV
QA		2.5:1	A	235790	A
CUST		DO NOT SCALE DRAWING			SHEET 7 OF 9
REVISED					

MODEL

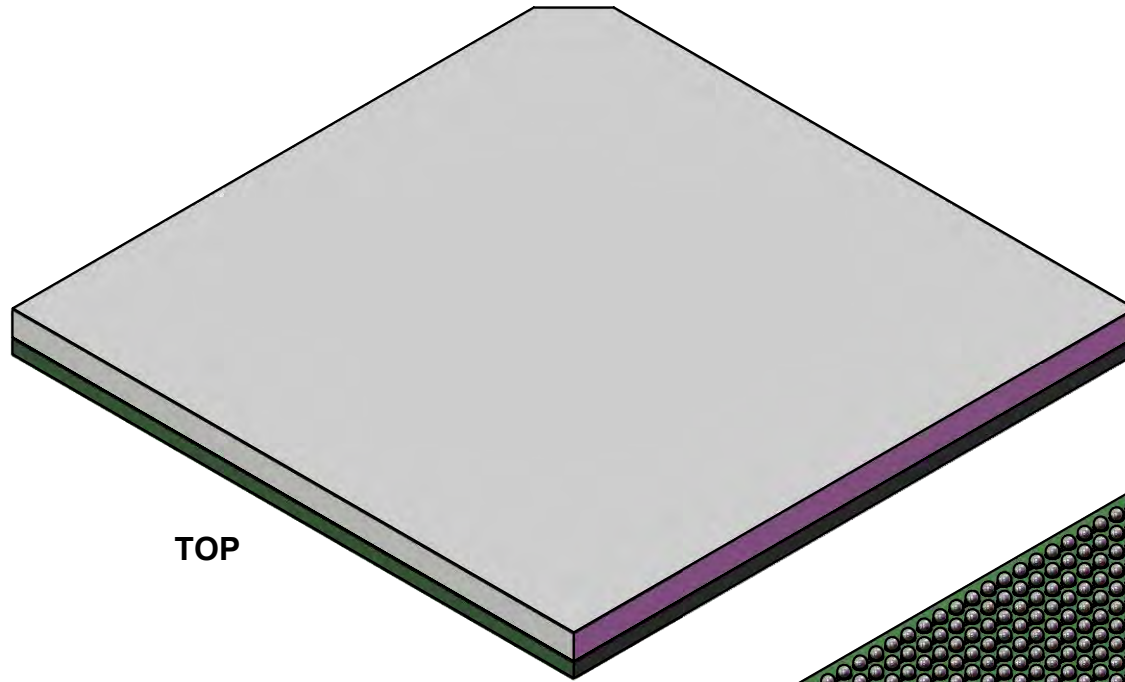

TOP

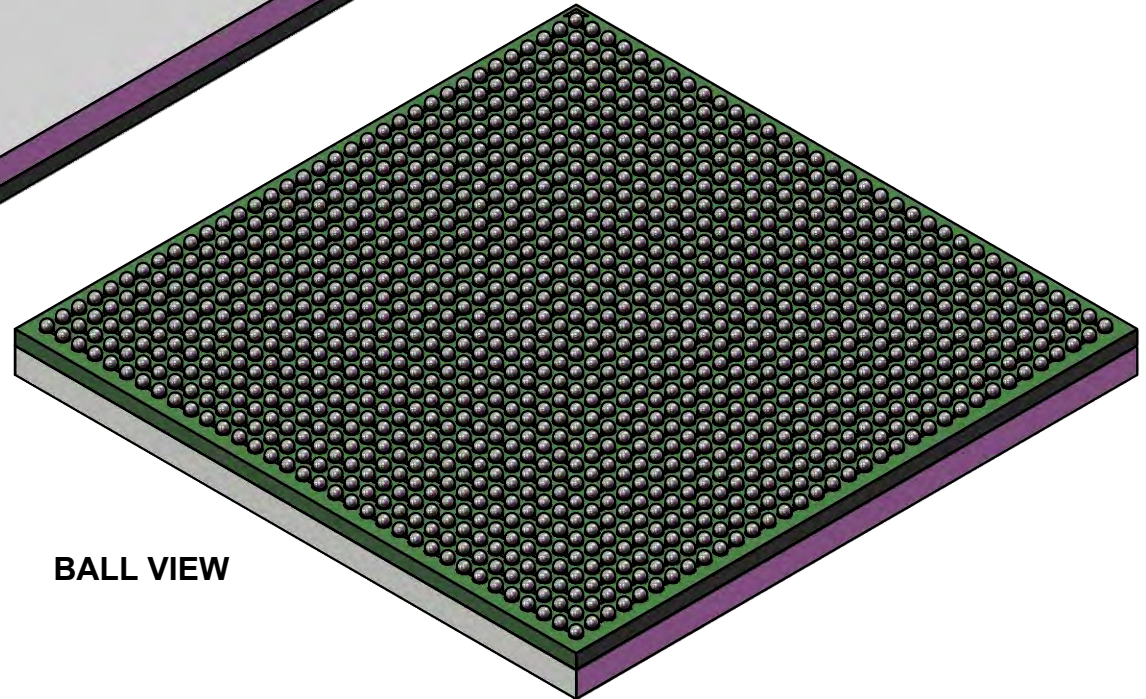

BALL VIEW

TopLine[®]

TITLE FF1156T1.0-DC349D
DAISY CHAIN DUMMY

SCALE 3:1	SIZE A	DRAWING NO. 513491	REV A
--------------	-----------	-----------------------	----------

DO NOT SCALE DRAWING

SHEET 8 OF 9

BOTTOM SOLDER MASK (RIGHT READING)

34 33 32 31 30 29 28 27 26 25 24 23 22 21 20 19 18 17 16 15 14 13 12 11 10 9 8 7 6 5 4 3 2 1

A
B
C
D
E
F
G
H
J
K
L
M
N
P
R
T
U
V
W
Y
AA
AB
AC
AD
AE
AF
AG
AH
AJ
AK
AL
AM
AN
AP

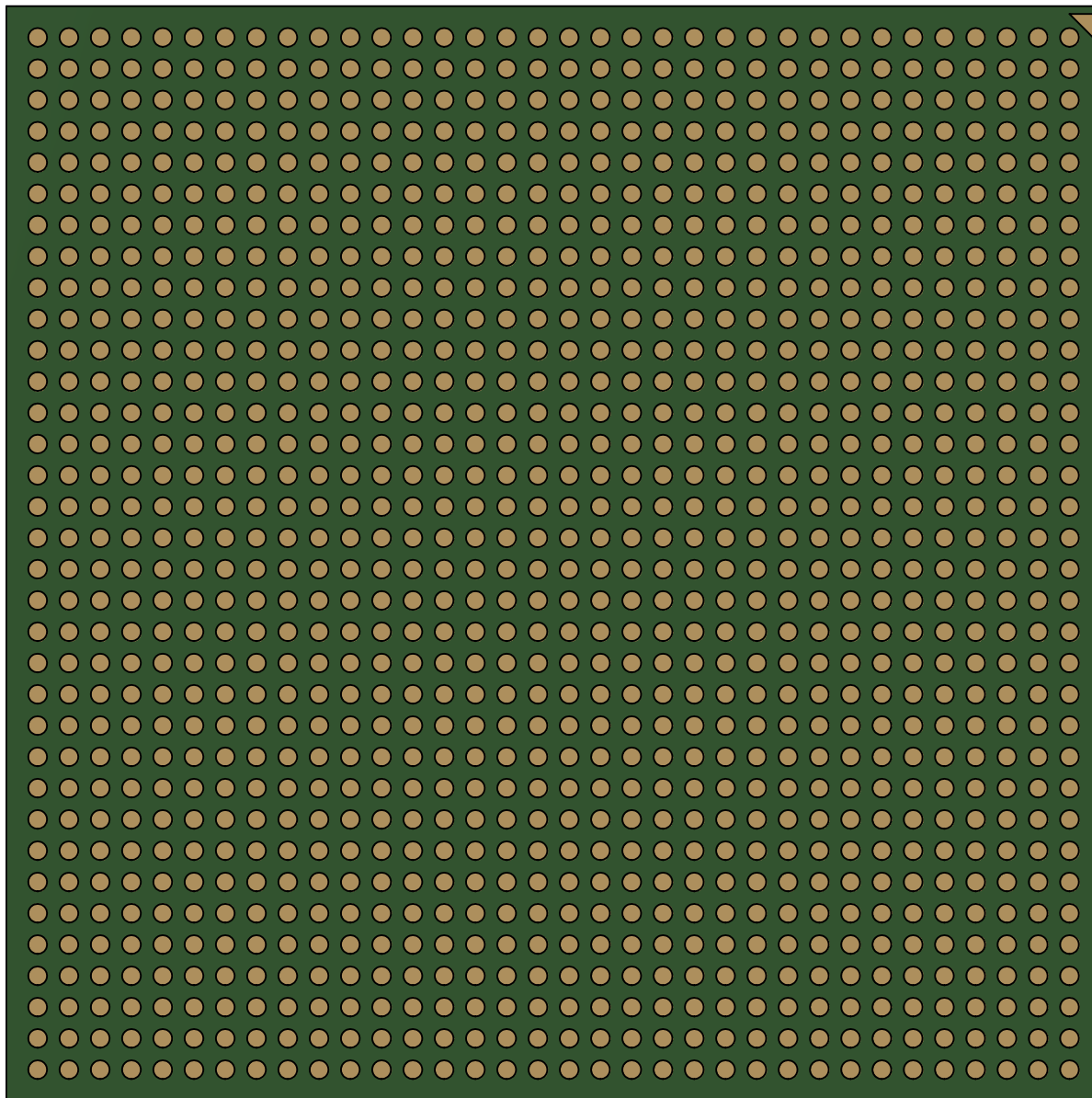

TopLine®			
TITLE		FF1156T1.0-DC349D DAISY CHAIN DUMMY	
SCALE	SIZE	DRAWING NO.	REV
4.5:1	A	513491	A
DO NOT SCALE DRAWING			SHEET 9 OF 9